

Lesson materials pack

Shopping and money

1. Lesson print outs / worksheets



A/B Shop
(Sheet A and
B)

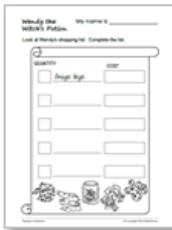

Reader
worksheet



Shopping
Board Game
Sheet 1



Shopping
Board Game
Sheet 2



How much is/
are? 1

2. Additional materials *These materials can used for extra practice or homework.*

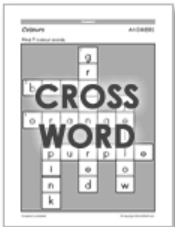

Shopping
vocab
crossword



Shopping
vocab word
search

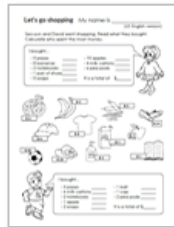

Let's go
shopping

3. Lesson materials not included in this pack *Access from our website.*

- **Wendy the Witch's Potion reader:** download PDF file and/or stream the video from our website.

A's Shopping List

Peas	\$
Kite	\$
Eraser	\$
Carrots	\$
Cereal	\$
Frying Pan	\$
Milk	\$
Pencil Case	\$
TOTAL	\$

SAMPLE FOR EVALUATION

Join ESL KidStuff/
to print without watermark

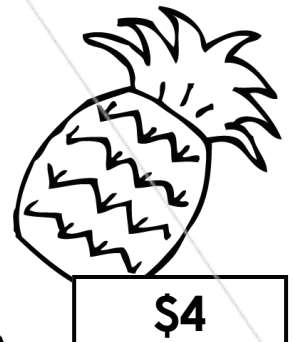
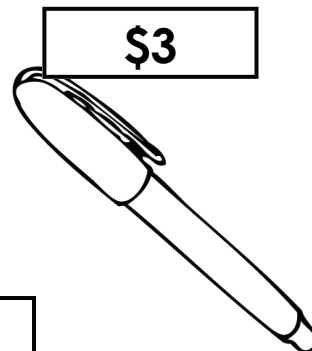
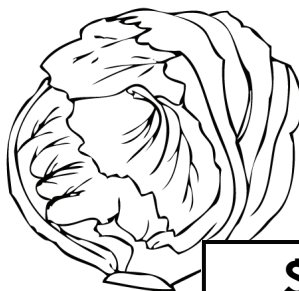
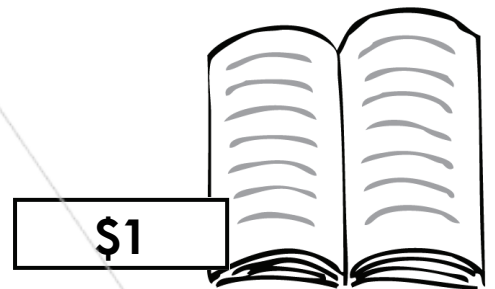
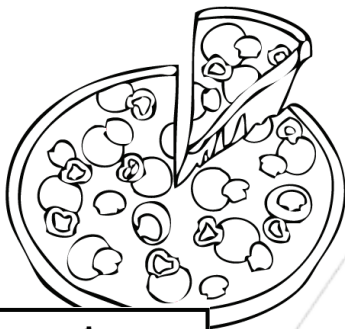
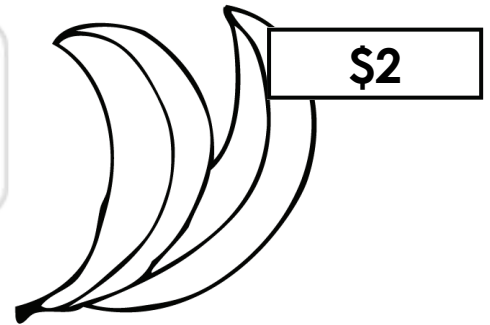

B's Shopping List

Note Book	\$
Pineapple	\$
Shampoo	\$
Pizza	\$
Bananas	\$
Pen	\$
Lettuce	\$
Cap	\$
TOTAL	\$

SAMPLE FOR EVALUATION

Join ESL KidStuff/
to print without watermark

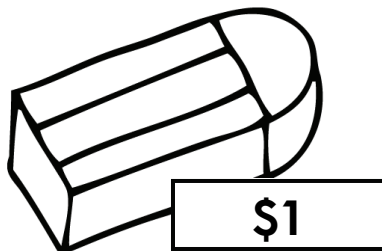
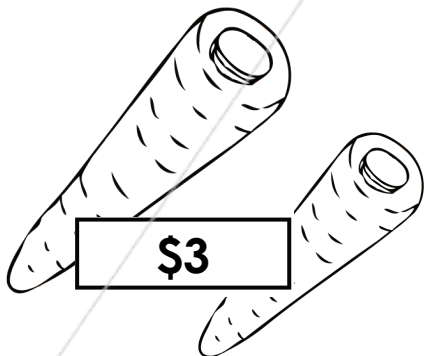
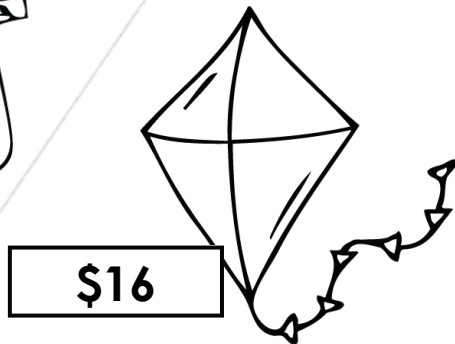
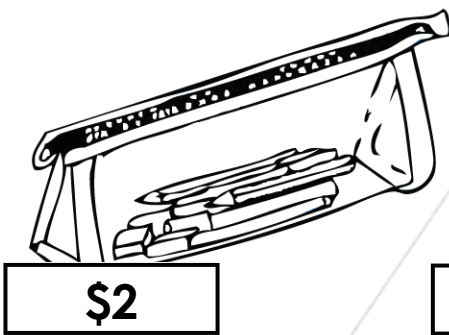
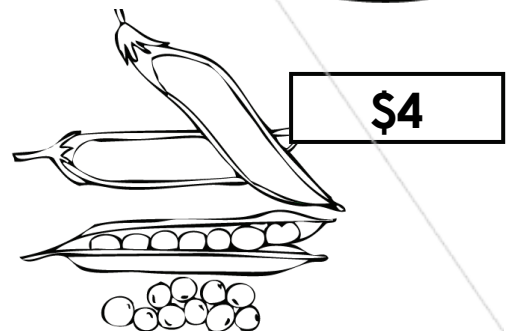
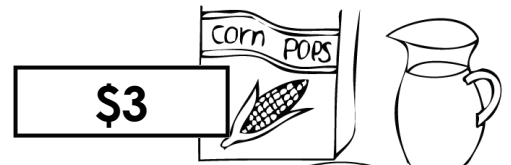
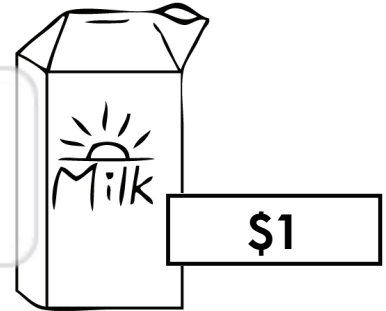

Wendy the Witch's Potion

My name is _____

Look at Wendy's shopping list. Complete the list.

QUANTITY

COST

frogs legs

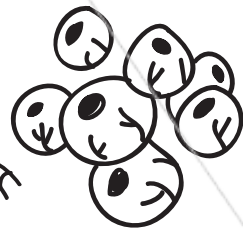
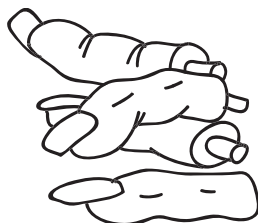

SAMPLE FOR EVALUATION

Join ESL KidStuff
to print without watermark

Shopping Game

Sheet 1

My name is _____

Use with Sheet 2. Play in pairs. Move around the board in turns. When you land on a square act out the dialog. Play until one player has bought all the items on their shopping list.

STUDENT A'S SHOPPING LIST

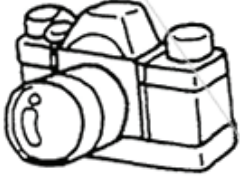

DIALOG

clerk: "May I help you?"
customer: "Yes. A camera please."
clerk: "Do you want a Nikon?"
customer: "Can you print without watermark?"
clerk: "Here you are."
customer: "Thank you. How much is it?"
clerk: "(It's) \$300"
customer: "Thank you."
clerk: "You're welcome"

or

clerk: "May I help you?"
customer: "No thank you. (I'm) just looking."









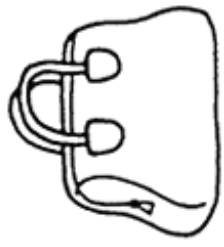

STUDENT B'S SHOPPING LIST

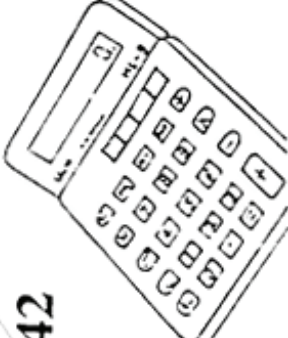

Shopping Game Sheet 2

Use with Shopping Game Sheet 1



START ⇒



 Canon / Nikon \$300	 Black / Brown \$47	 tennis shoes / jogging shoes \$55	 Fuji / Kodak \$3.50
 Seiko / Citizen \$75	<p>SAMPLE FOR EVALUATION Join ESL KidStuff to print without watermark</p>		 Casio / Canon \$42
 Levi's / Edwin \$33			 Man's / Woman's \$200
 leather / wool \$120	 Large / Small \$22	 red / blue \$15	 soccer ball / volleyball \$80



HOW MUCH IS/ARE 1?

My name is _____

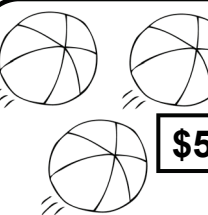

Complete the questions and answers

	<p>What <u>is it</u>? <u>It's an apple.</u> How much <u>is it</u>? <u>It's \$1.</u></p>		<p>What <u>are they</u>? <u>They are bananas.</u> How much <u>are they</u>? <u>They are \$3.</u></p>
----------------------------------------------------------------------------------	----------------------------------------------------------------------------------------------------------------	------------------------------------------------------------------------------------	-----------------------------------------------------------------------------------------------------------------------------

	<p>What _____? <u>It's _____.</u> How much _____? <u>It's _____.</u></p>		<p>What _____? <u>They _____.</u> How much _____? <u>They are _____.</u></p>
----------------------------------------------------------------------------------	-------------------------------------------------------------------------------------------------	------------------------------------------------------------------------------------	-----------------------------------------------------------------------------------------------------

	<p>_____? _____. _____? _____.</p>		<p>_____? _____. _____? _____.</p>
-----------------------------------------------------------------------------------	---------------------------------------------------------------------------	-------------------------------------------------------------------------------------	---------------------------------------------------------------------------

SAMPLE FOR EVALUATION
 Join ESL KidStuff
 to print without watermark

	<p>_____? _____. _____? _____.</p>		<p>_____? _____. _____? _____.</p>
------------------------------------------------------------------------------------	---------------------------------------------------------------------------	--------------------------------------------------------------------------------------	---------------------------------------------------------------------------

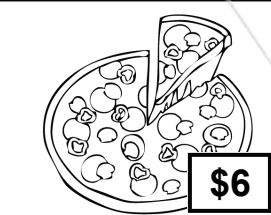
	<p>_____? _____. _____? _____.</p>		<p>_____? _____. _____? _____.</p>
------------------------------------------------------------------------------------	---------------------------------------------------------------------------	--------------------------------------------------------------------------------------	---------------------------------------------------------------------------

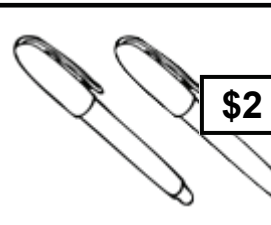
	<p>_____? _____. _____? _____.</p>		<p>_____? _____. _____? _____.</p>
------------------------------------------------------------------------------------	---------------------------------------------------------------------------	--------------------------------------------------------------------------------------	---------------------------------------------------------------------------

pizza ball ~~banana~~ pen strawberry note book
 shoe kite ~~apple~~ pineapple tomato shirt

Shopping

My name is _____

SAMPLE FOR EVALUATION
Join ESL KidStuff
to print without watermark

Down ↓

Across →

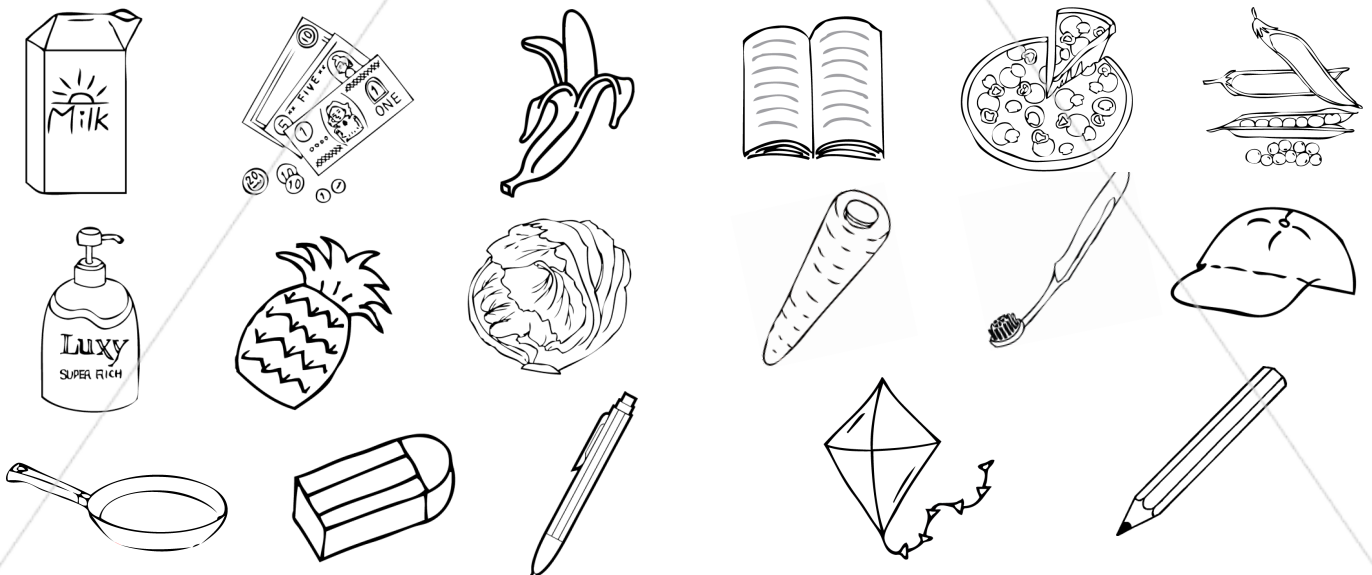

Shopping

ANSWERS

Down ↓

Across →

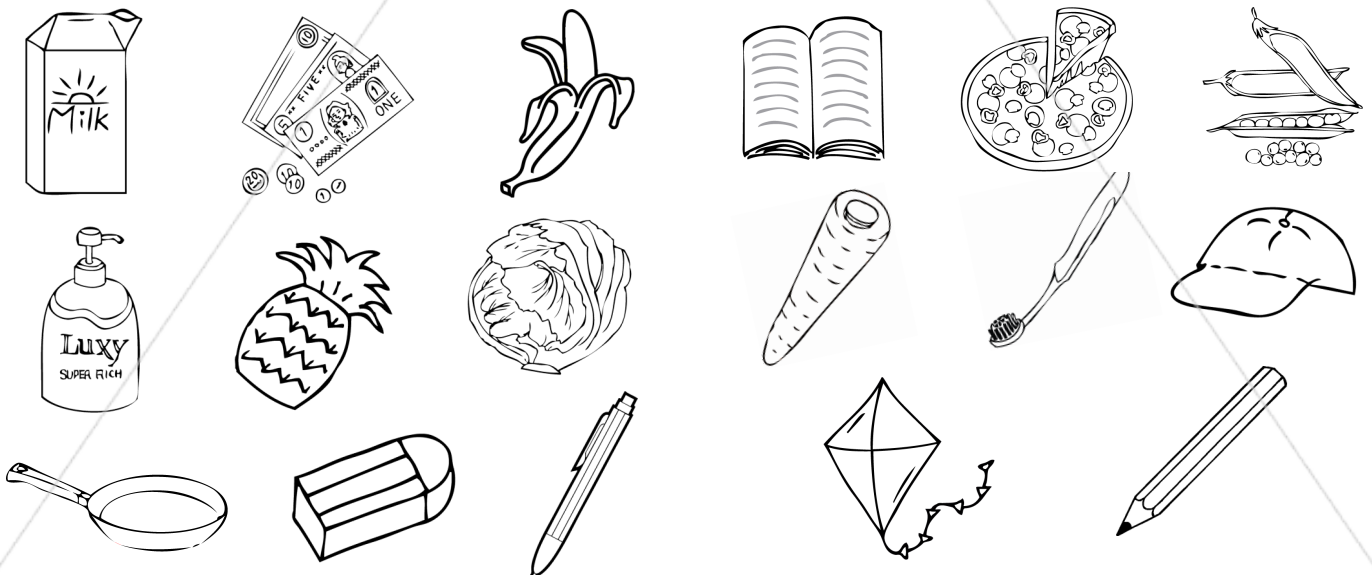

Shopping

My name is _____

t	c	f	c	b	a	n	a	n	a	s	m	w	c	o
c	t	p	a	b	a	f	r	y	i	n	g	p	a	n
e	c	o	p	y	a	n	k	e	b	q	d	h	r	g
r	q	r	o	z	o	o	o	r	c	k	z	f	r	y
e	u	y	v	t	k	t	d	a	f	d	c	h	o	t
a	a	w	m	k	h	e	i	s	h	b	l	b	t	r
l	s	p	o	b	c	b	l	e	h	p	e	f	t	h
f	h	i	n	k	g	o	r	r	q	e	t	h	y	m
c	a	n	e	i	z	o	w	u	p	a	t	z	i	s
s	m	e	y	t	s	k	j	p	s	s	u	h	q	w
p	p	a	c	e	p	e	n	q	o	h	c	b	u	t
e	o	p	m	d	u	l	k	q	m	v	e	p	e	s
v	o	p	f	n	p	e	n	c	i	l	c	a	s	e
t	c	l	o	d	t	a	p	m	l	g	p	x	p	l
p	k	e	h	p	i	z	z	a	k	p	j	e	b	f

SAMPLE FOR EVALUATION
 Join ESL KidStuff
 to print without watermark

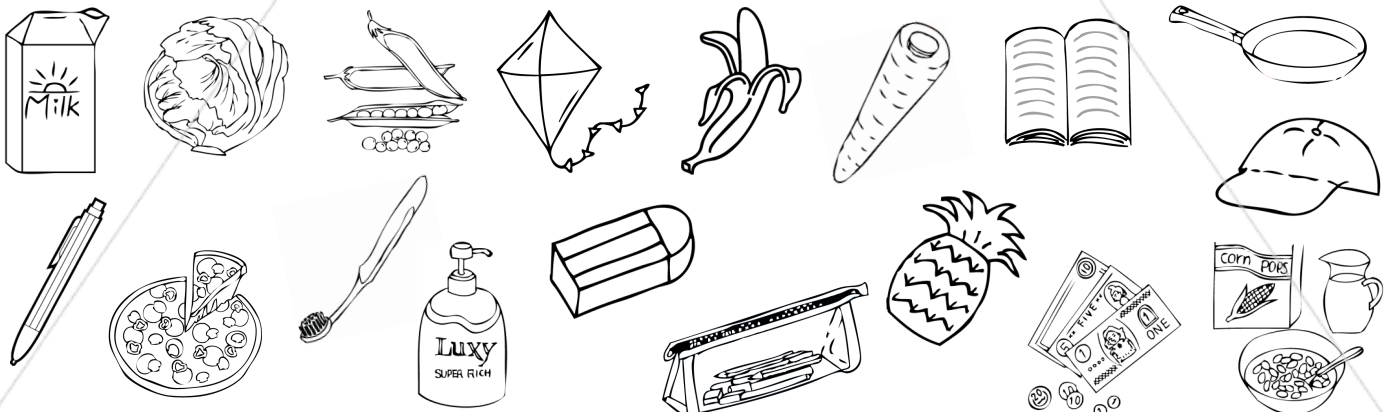

Shopping

ANSWERS

t	c	f	c	b	a	n	a	n	a	s	m	w	c	o
c	t	p	a	b	a	f	r	y	i	n	g	p	a	n
e	c	o	p	y	a	n	k	e	b	q	d	h	r	g
r	q	r	o	z	o	o	o	r	c	k	z	f	r	y
e	u	y	v	t	k	t	d	a	f	d	c	h	o	t
a	a	w	m	k	h	e	i	s	h	b	l	b	t	r
l	s	p	o	b	c	b	l	e	h	p	e	f	t	h
f	h	i	n	k	g	o	r	r	q	e	t	h	y	m
c	a	n	e	i	z	o	w	u	p	a	t	z	i	s
s	m	e	y	t	s	k	j	p	s	s	u	h	q	w
p	p	a	c	e	p	e	n	q	o	h	c	b	u	t
e	o	p	m	d	u	l	k	q	m	v	e	p	e	s
v	o	p	f	n	p	e	n	c	i	l	c	a	s	e
t	c	l	o	d	t	a	p	m	l	g	p	x	p	l
p	k	e	h	p	i	z	z	a	k	p	j	e	b	f

SAMPLE FOR EVALUATION
 Join ESL Kid Stuff
 to print without watermark

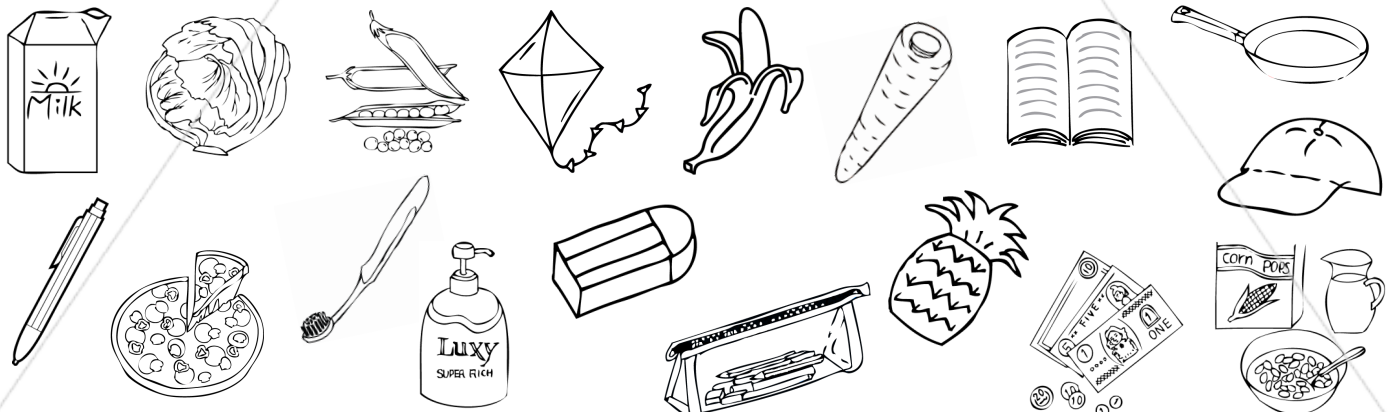

Let's go shopping

My name is _____
(US English version)

Seo-yun and David went shopping. Read what they bought. Calculate who spent the most money.

I bought...

- | | |
|-------------------------|---------------------------|
| - 5 pizzas _____ | - 10 apples _____ |
| - 8 bananas _____ | - 4 milk cartons _____ |
| - 2 notebooks _____ | - 6 pea pods _____ |
| - 1 pair of shoes _____ | |
| - 5 soaps _____ | It is a total of \$ _____ |



SAMPLE FOR EVALUATION
Join ESL KidStuff
to print without watermark

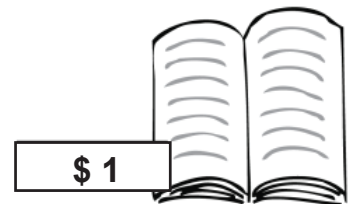
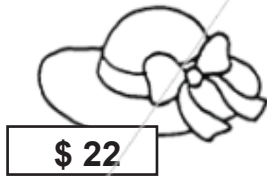
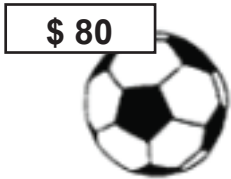

I bought...

- | | |
|------------------------|---------------------------|
| - 3 pizzas _____ | - 1 ball _____ |
| - 6 milk cartons _____ | - 1 cap _____ |
| - 2 notebooks _____ | - 2 pea pods _____ |
| - 1 apple _____ | |
| - 2 soaps _____ | It is a total of \$ _____ |